



Yaşam Alanlarınıza Değer Katar

2023  
**MODEL STEELLINE LUX**  
WC CUBICLE CATALOGUE  
08

SANDER

S  
I  
N  
C  
E  
2001

## Our Brand **Vision**

**From Turkey to the World**, with **environmental**,  
ecological, and national values...

## EXPORT TO 26 DIFFERENT COUNTRIES



Since 2001, SANDER, the industry leader, has expanded its production and export volume.

It is a global brand that is continually expanding.

With cubicle manufacture, we specialize in providing comfort to living areas.

"High quality service at an affordable price" has been our motto from the day we opened our doors.

Our enterprise, which operates entirely with local capital and products, generates both employment and significant economic contributions to our country.

A model structure in terms of the significance it places on technology, R&D, design, and human resources.

SANDER, which is a "sustainable" discipline concept, gains an environmental business strategy.

Because of its environmental business strategy, SANDER is a "sustainable" discipline concept. acquires.

SANDER, which continuously decreases its carbon emissions through a regulated follow-up, plans to meet the "zero waste" aim by 2030.

The tagline "Adds value to your living spaces" inspires the design of practical, colorful, and dependable items.

SANDER provides comfort in over 20 nations.





#### INCENTIVE

The **Stelline Lux** product line, passion, warmth, intimacy, and power, features a variety of colors that signify excitement and confidence. The color tones it includes promote speedy and effective decision making. As a result, he is in high demand in the fields of labor, education, and health.

Satin stainless steel is used for the **Stelline Lux** product group's connection, support, and complimentary parts, which are featured in the select SANDER range (SSS 304 quality). It offers a strong abrasion resistance and a five-year warranty.

This product readily adjusts to your living environments by providing alternatives to meet your comfort standards, audience, and likes. Adjustable foot heights often aid in adapting to wet volumes and surface gradients.

**MODEL STEELLINE LUX**  
**Product Code: 10108A012**





## Value Adding **Features**

### Quality details and advantages;

- Our panels are 12 mm thick and water and humidity resistant.
- Our panels are antibacterial and feature easy-to-clean surfaces.
- Our cabins' panels and fasteners are certified.
- This product line makes use of first-rate album raw materials.
- Satin stainless steel is used to make connection, support, and complimentary pieces (SSS 304 quality).
- Steel materials have received a unique coating (SSS permalast) that improves corrosion resistance.
- Product line of the SANDER Stelline Lux series.
- Produced with cutting-edge technology and engineering expertise.
- It has been designed with the notion of adding value to living spaces in mind.
- Designs that were unique, innovative, and colorful were employed.
- Water, humidity, heat, and cold have no effect on it.
- It has a strong abrasion resistance.
- It is entirely made in Turkiye.
- It creates direct jobs and contributes to the Turkish economy.
- Customer satisfaction is prioritized both before and after the transaction.
- The choice is yours: We can also produce steel accessories in the quality of SSS 316.

*Comfort is in the details.*



With A Three-Dimensional Perspective  
**PRECISE DETERMINATION, AND DEFINITIVE SOLUTION**

TOP VIEW

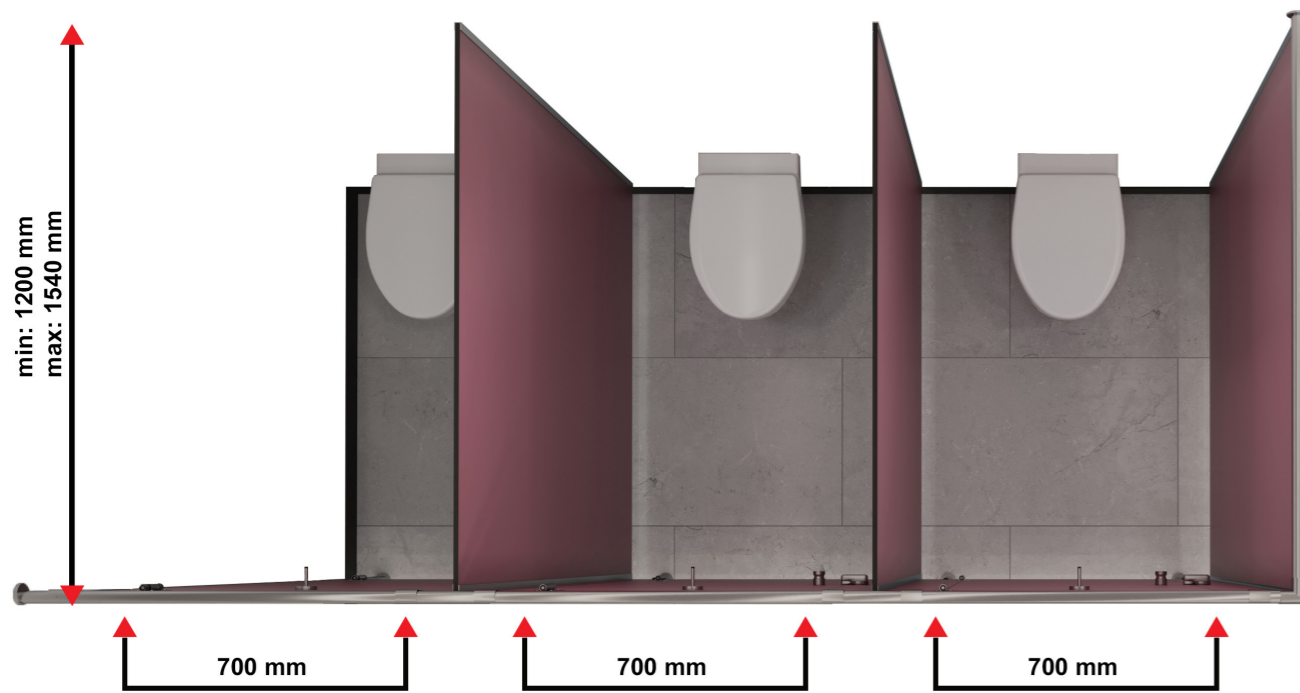

FRONT VIEW





**S S 01 X 012**

SANDER MODEL NAME PRODUCT CODE PRODUCT TYPE PANEL THICKNESS



**SS08X012 HANGER**

- It's made of 304 quality stainless steel.
- It is corrosion-free within the guarantee term.
- Water and humidity resistant.
- Plastic material is added at the product's end to serve as a stopper and prevent impacts.
- It is capable of transporting up to 10 kilograms.



**SS05X012 LOCK**

- They're compatible with both 12 mm and 18 mm HPL panels.
- It has a latch and dial mechanism.
- It has a 304 quality stainless steel profile latch, twisted body, and arm.
- It uses the latch turning mechanism to lock.
- It has a latch and dial, and with the colored mechanism (red-green) on it, it displays from the outside whether the door is busy or not.
- It is interfered from the outside in case of an emergency.



**PS0112X U-CONNECTION PROFILE**

- The edges of the panel are not visible when the cabin system spins thanks to the application of this connection piece.
- The U profile's exterior dimensions will be 22 x 15 mm, with a wall thickness of 1.5 mm.
- It will be used to link U profile-Wall and U profile-Divider Panels.
- Its dimensions are 4.2 x 11 mm. Thick threaded, stainless steel screws are used to fasten it.



**PS0312X DOOR PROFILE**

- It is an inox profile that serves as a boarding at the door by attaching to fixed panels.
- This item measures 4.2 x 11 mm. coarse thread, fastened with 304 stainless screws, in the Y1B style.



**PS0412X CORNER CONNECTION PROFILE**

- The edges of the panel are not visible when the cabin system spins thanks to the application of this connection piece.
- Size: 30 x 30 mm.
- Compact laminate panels will grab the corner profile on all sides.
- This product attached using 304 grade stainless steel screws with a coarse thread measuring 4.2 x 11 mm.



**SS09X012 GRIP**

- It is produced of 304 stainless steel.
- It is 35 mm in diameter, and 40 mm in length.
- It has an MBx35 grub screw connection.
- It is not affected by water, humidity and corrosion.
- Its warranty is covered by SANDER's guarantee.



**SS04X012 HINGE-SPRINGLESS**

- The flat (Tongue-Groove) style door systems category includes this product.
- Metal pieces'll be composed of stainless steel.
- The hinge covers won't have any visible wings.
- They're compatible with both 12 mm and 18 mm HPL panels.
- 90 mm in height and 70 mm in width.



**SS0512X TOP PANEL PROFILE**

- Profiles will be installed on the cabinet system's top, front, and side edges.
- A square profile with dimensions of 50 mm x 45 mm and a wall thickness of 1.2 mm will be utilized as the header profile.



**SS03X012 HINGE-SPRING**

- The flat (Tongue-Groove) style door systems category includes this product.
- Metal pieces'll be composed of stainless steel.
- The hinge covers won't have any visible wings.
- They're compatible with both 12 mm and 18 mm HPL panels.
- 90 mm in height and 70 mm in width.



**SS01X012 LEG**

- The size range is 100-150 mm with a diameter of 27mm.
- It has 52 mm diameter leg cover.
- This accessory's adjustable height ranges from 100mm to 150mm.
- The material will be protected by a 12.5 mm duct in a compact laminate panel.
- The leg foundation will be secured to the ground using PA6 shoes that are attached with stainless screws at at least three distinct spots.



**SS01X012 LEG**

- The size range is 100-150 mm with a diameter of 27mm.
- It has 52 mm diameter leg cover.
- This accessory's adjustable height ranges from 100mm to 150mm.
- The material will be protected by a 12.5 mm duct in a compact laminate panel.
- The leg foundation will be secured to the ground using PA6 shoes that are attached with stainless screws at at least three distinct spots.



**SS01X012 LEG**

- The size range is 100-150 mm with a diameter of 27mm.
- It has 52 mm diameter leg cover.
- This accessory's adjustable height ranges from 100mm to 150mm.
- The material will be protected by a 12.5 mm duct in a compact laminate panel.
- The leg foundation will be secured to the ground using PA6 shoes that are attached with stainless screws at at least three distinct spots.

**TOP VIEW**

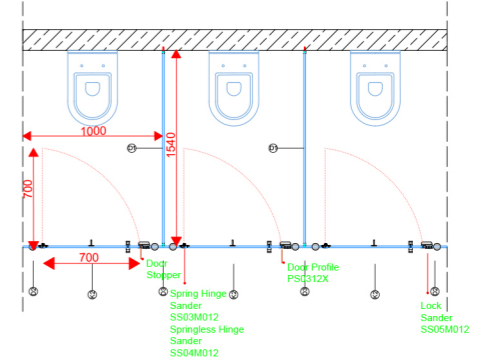

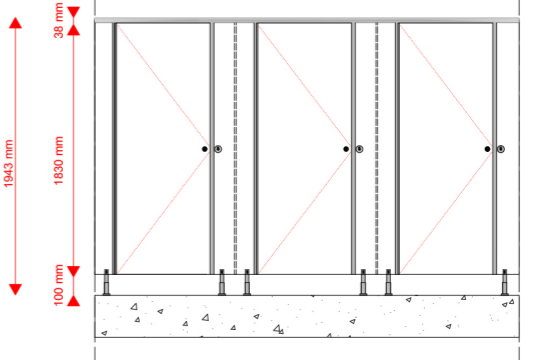

**FRONT VIEW**

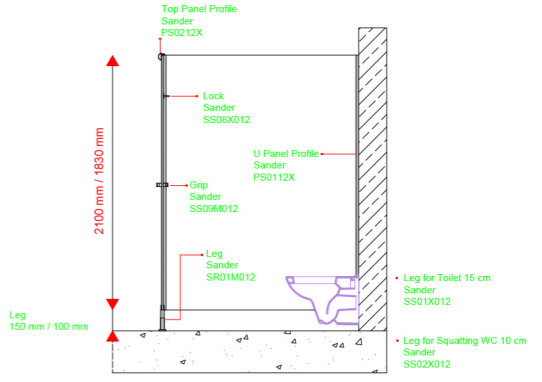

**SIDE VIEW**









**HINGE DETAIL**



**DOOR DETAIL**



**LOGO DETAYI**  
Her bir kabin panelinin arkası yüzüne, belli aralıklarla CNC matkap ile logo kazıyacaktır.



**LOCK DETAIL**

**PANELS**  
The feature is 12 mm Compact laminate panels with double surface decorative, water, scratch, and break resistant, bacteria free, and fire retardant. CGS - CGF EN 438-4 class

**LOCK**  
The door shows if it is busy from the outside by turning the colored mechanism on the latch (TURNED). 304 Stainless Steel

**HINGE**  
Doors with profile rebates (BINI PROFILE SYSTEM) are used in door systems. It features a self-closing spring mechanism and is made of 304 STAINLESS STEEL.

**LEG**  
Anti-bacterial plastic floor connection, 304 stainless steel. The adjustable height is 100-150 mm, making it suited for moist regions in general. It aids in adapting to the current slope.

**CONNECTIONS AND PROFILES**  
At junctions, head profiles and "U" profiles 304 stainless steel, panel-wall, and panel-panel are utilized. Fasteners used in cabinet assembly are all stainless steel.





**Accessories**





## Leg

### Product Code - SS01X012

- The size range is 150–200 mm, with a diameter of 27mm.
- This accessory's adjustable height ranges from 150mm to 200mm.
- It has 52 mm diameter leg cover.
- The material will be protected by a 12.5 mm duct in a compact laminate panel.
- The leg foundation will be secured to the ground using PA6 shoes that are attached with stainless screws at at least three distinct spots.
- They're linked to the anti-bacterial plastic floor at three points.
- They're compatible with both 12 mm and 18 mm HPL pannels.
- It has a carrying capacity of 70 kg.
- Water and humidity resistant.



NOT AFFECTED  
BY WATER



CORROSION  
RESISTANT



MATERIAL 304  
STAINLESS STEEL  
INOX



Certificate Certificate  
CE ISO 9001:2015

0,222 kg

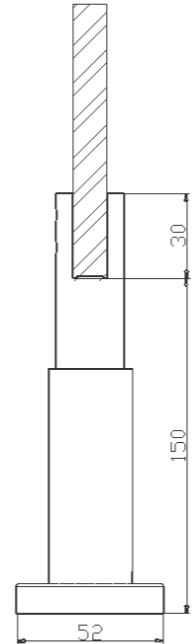

Details matter when it comes to quality.

It is appropriate for wet areas in general and has an adjustable height of 150–200 mm. helps you adjust to the surface's slope.







## Leg

Product Code - SS02X012



- The size range is 100-150 mm, with a diameter of 27mm.
- This accessory's adjustable height ranges from 100mm to 150mm.
- It has 52 mm diameter leg cover.
- The material will be protected by a 12.5 mm duct in a compact laminate panel.
- The leg foundation will be secured to the ground using PA6 shoes that are attached with stainless screws at at least three distinct spots.
- They're linked to the anti-bacterial plastic floor at three points.
- They're compatible with both 12 mm and 18 mm HPL pannels.
- It has a carrying capacity of 70 kg.
- Water and humidity resistant.

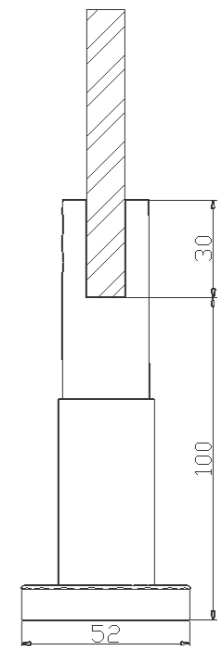



# Hinge - Spring

Product Code - SS03X012

- The flat (single face) style door systems category includes this product.
- Metal pieces will be composed of stainless steel.
- They're compatible with both 12 mm and 18 mm HPL pannels.
- The hinge covers won't have any visible wings.
- 90 mm in height and 70 mm in width.
- 18 mm. In the nest, it will function.
- It enables the doors to close on their own.
- It has a mechanism with springs.



NOT AFFECTED  
BY WATER



CORROSION  
RESISTANT



MATERIAL 304  
STAINLESS STEEL  
INOX

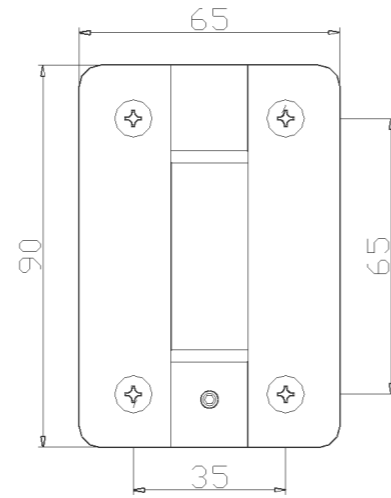
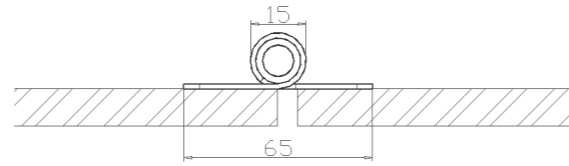
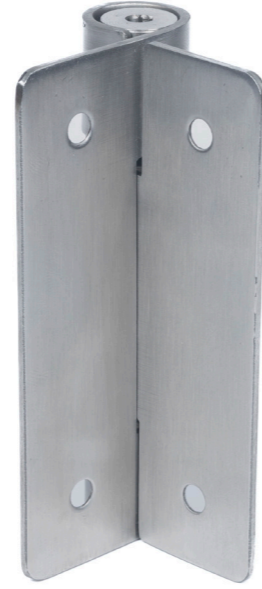

0,220 kg







## Hinge - Springless

Product Code - SS04X012



NOT AFFECTED  
BY WATER



CORROSION  
RESISTANT



MATERIAL 304  
STAINLESS STEEL  
INOX

- The flat (single face) style door systems category includes this product.
- Metal pieces will be composed of stainless steel.
- They're compatible with both 12 mm and 18 mm HPL pannels.
- The hinge covers won't have any visible wings.
- 90 mm in height and 70 mm in width.
- 18 mm. In the nest, it will function.
- It enables the doors to close on their own.
- It has a mechanism without springs.



0,236 kg



Certificate  
CE



Certificate  
ISO 9001:2015

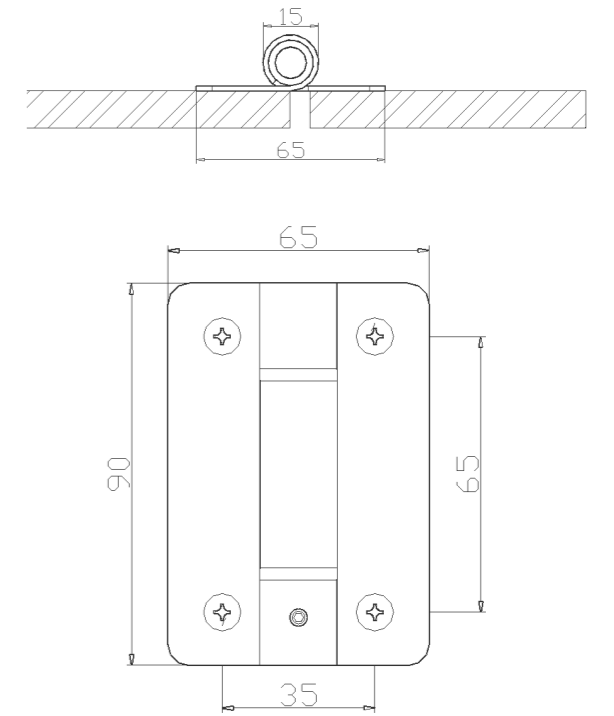

Details matter for comfort.

The hinges to the doors' centers of gravity can be modified appropriately. This method, automated door closure is offered.



# Lock

Product Code - SS05X012

- They're compatible with both 12 mm and 18 mm HPL panels.
- It has a latch and dial mechanism.
- It has a 304 quality stainless steel profile latch, twisted body, and arm.
- It uses the latch turning mechanism to lock.
- It has a latch and dial, and with the colored mechanism (red-green) on it, it displays from the outside whether the door is busy or not
- it is interfered from the outside in case of an emergency.



NOT AFFECTED  
BY WATER



CORROSION  
RESISTANT



MATERIAL 304  
STAINLESS STEEL  
INOX

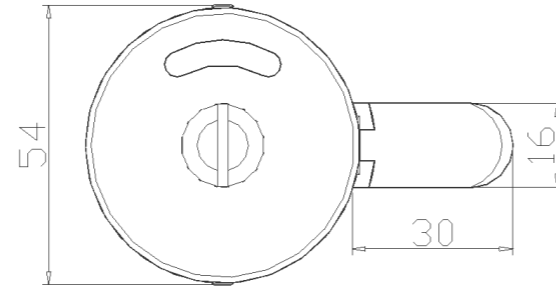

0,186 kg



## In the details lies security.

The exterior cover has an on/off indication. For emergency interventions, there is a handle inside that may be opened with any pointed item from the outside.





# Hanger

Product Code - SS08X012

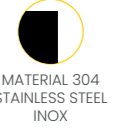

- It's made of 304 quality stainless steel.
- It is corrosion-free within the guarantee term.
- Water and humidity resistant.
- Plastic material is added at the product's end to serve as a stopper and prevent impacts.
- It is capable of transporting up to 10 kilograms.

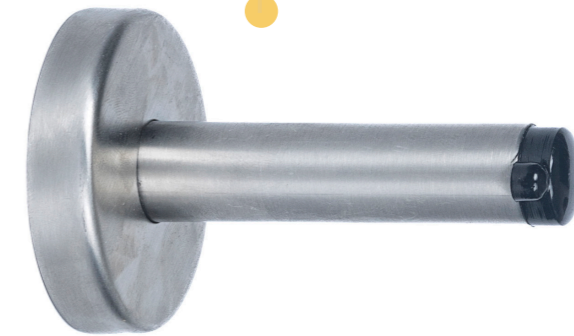
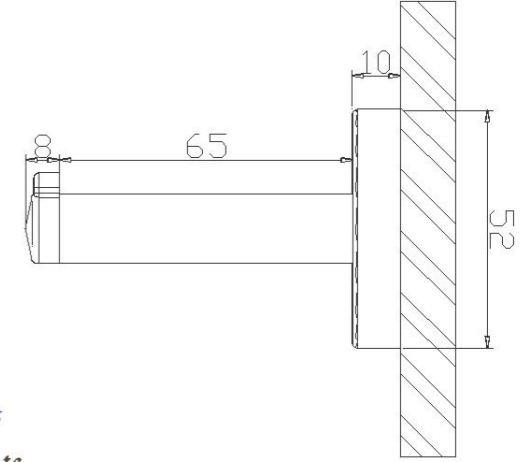

**Our difference hidden in the details.**

The hangers will be held together by YHB 4.2 x 11 mm thick threaded 304 stainless screws.



# Grip

Product Code - SS09X012

- It is produced of 304 stainless steel.
- It is 35 mm in diameter, and 40 mm in length.
- It has an M8x35 grub screw connection.
- It is not affected by water, humidity and corrosion.
- Its warranty is covered by SANDER's guarantee.

0,256 kg

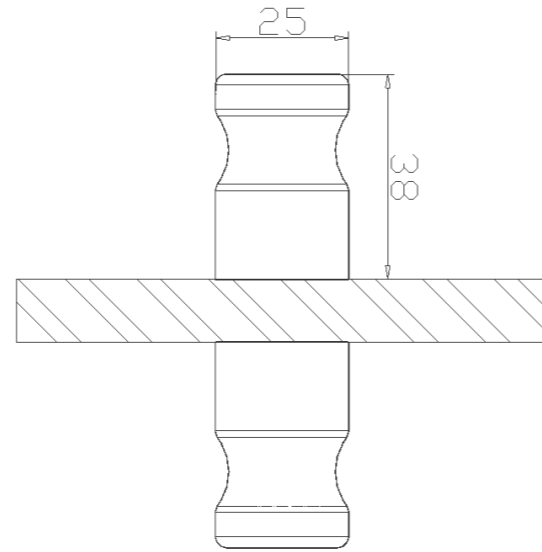

**Aesthetic is in the details.**

Details conceal double-sided use. In order for the doors to open and close practically, this substance is applied on both sides.





## Top Pannel Connection

Product Code - SS10X012

- It is the original top panel connection accessory.
- It serves to keep the panels from wobbling when connected.
- The product form is T-shaped and has a diameter of 27 mm.
- Made of stainless steel of the 304 grade.
- Dowels suited for the type of wall are chosen while applying the product.
- Top connector with a 4.2x11 mm coarse thread made of 304
- Using high-quality stainless steel screws, it is secured.

### Details hold strength.

It increases the cabinet's durability by grabbing the compact laminate panels from the top. Iking for this product's aesthetics, which emphasize the view.



NOT AFFECTED BY WATER



CORROSION RESISTANT



MATERIAL 304 STAINLESS STEEL INOX

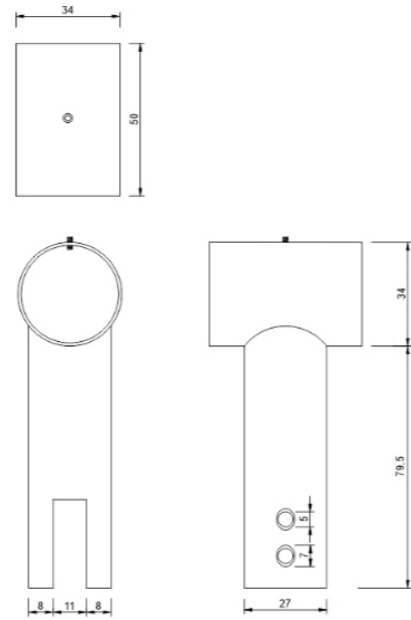

## Wall Connection

Product Code - SS11X012

- This product is used to install the original top panel connecting pipe to the wall.
- Top panel fixed holder made of 304 quality stalline stainless steel.
- They're compatible with both 12 mm and 18 mm HPL panels.

### Details determine sturdiness.

It is secured to the ground using stainless screws at a minimum of three separate locations on the wall (with attached PA6 lugs).



NOT AFFECTED BY WATER



CORROSION RESISTANT



MATERIAL 304 STAINLESS STEEL INOX

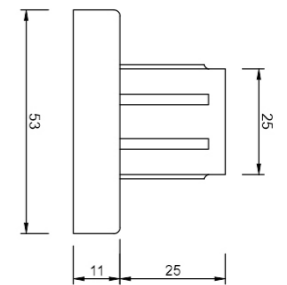
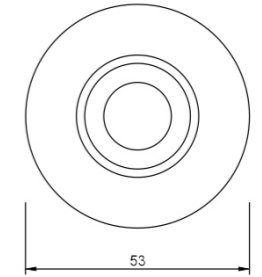
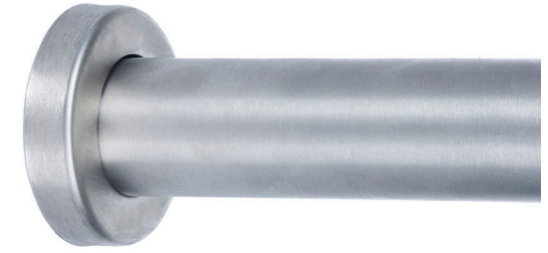



## 90° Adapter

Product Code - SS13012X

- It has a 'L' form and a 32 mm diameter.
- It serves a purpose in connecting the wall and partition panels.
- This item is constructed of 304 stainless steel.
- It is linked to the top panel pipe in corner turn cabinets with two M4\*8 grub screws.



NOT AFFECTED  
BY WATER



CORROSION  
RESISTANT



MATERIAL 304  
STAINLESS STEEL  
INOX



Certificate  
CE

Certificate  
ISO 9001:2015



Longevity is found in the details.

It is an inox profile used to connect the panels to the wall and other panels.





### Details hold strength.

It increases the cabinet's durability by grabbing the compact laminate panels from the top. Iking for this product's aesthetics, which emphasize the view.



## Top Pannel Connection Bracket

Product Code - SS17X012

- Top header connection.
- It serves to keep the panels from wobbling when connected.
- The product form is pipe and has a diameter of 27 mm.
- Made of stainless steel of the 304 grade.
- When using the product, it is connected to the wall connection equipment and affixed to the wall.
- Top connector with a 4.2x11 mm coarse thread made of 304.
- Using high-quality stainless steel screws, it is secured.

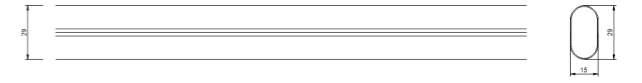



## Inox U Pannel Connection Profile

Product Code - PS01112X

- The edges of the panel are not visible when the cabin system spins thanks to the application of this connection piece.
- The U profile's exterior dimensions will be 22 x 15 mm, with a wall thickness of 1.5 mm.
- It will be used to link U profile-Wall and U profile-Divider Panels.
- Its dimensions are 4.2 x 11 mm. Thick threaded, stainless steel screws are used to fasten it.

183 cm

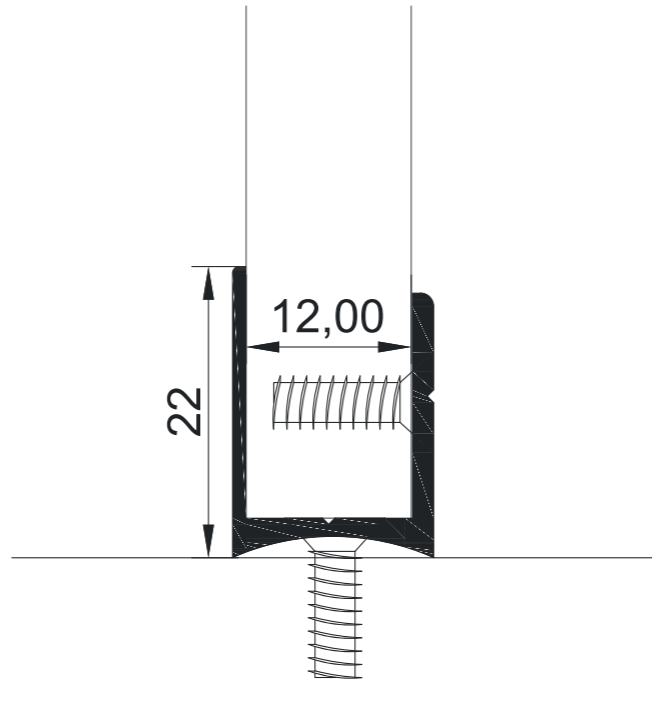

Details determine longevity.

Made with inox profile to fasten panels to walls and other panels.





## Inox Corner Connection Profile

Product Code - PS0412X

The details provide resistance against time.

The corners are made of 304 stainless steel and are rounded with an R15 radius.

- The edges of the panel are not visible when the cabin system spins thanks to the application of this connection piece.
- Size: 30 × 30 mm.
- Compact laminate panels will grab the corner profile on all sides.
- This product attached using 304 grade stainless steel screws with a coarse thread measuring 4,2 x 11 mm.

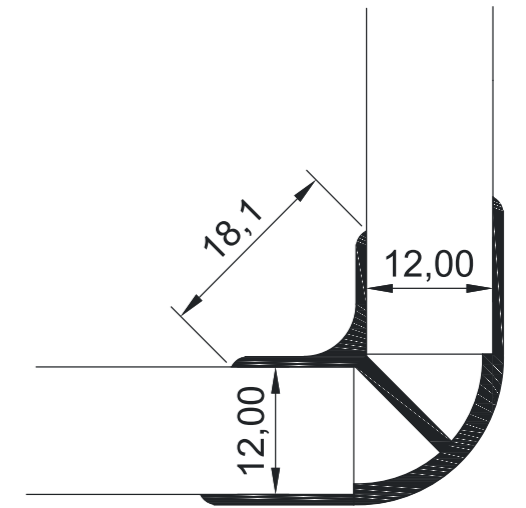

### Stock Colors

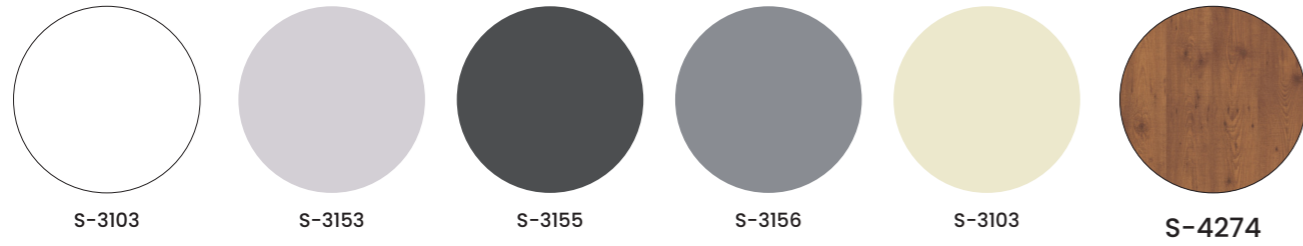

It is possible to prefer static paint with RAL color chart code for accessory products.



### Solid Colors (Out of Stock Production Process 4-8 weeks)

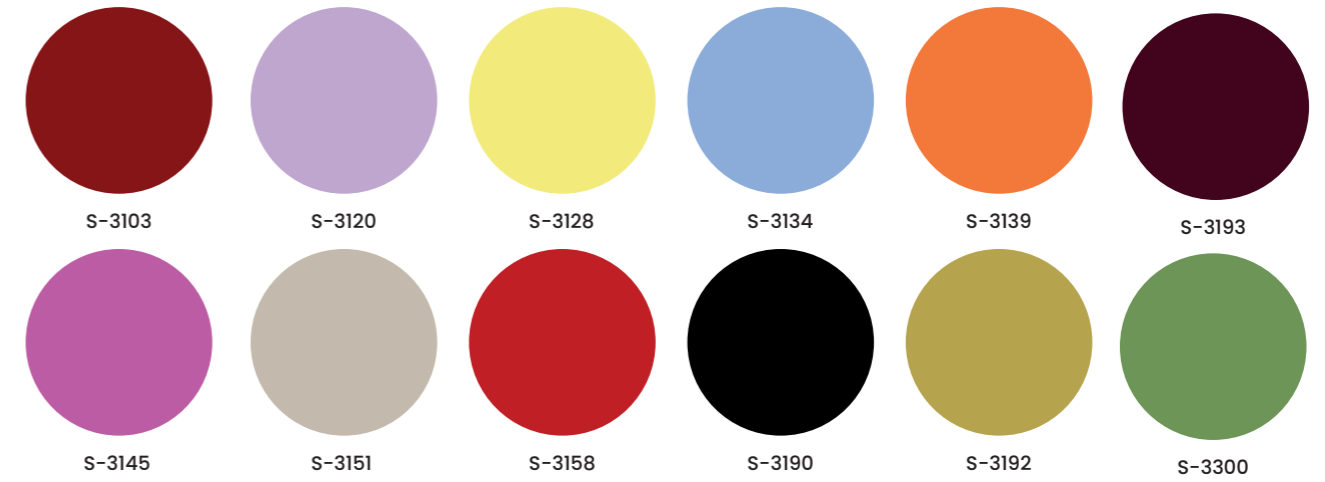

### Wood Colors (Out of Stock Production Process 4-8 weeks)

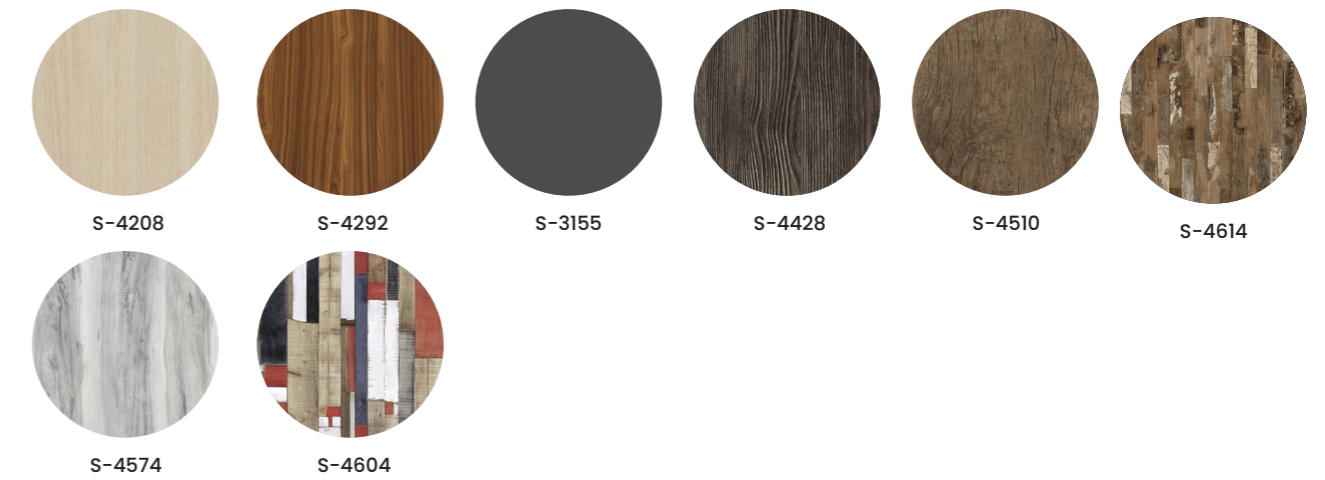

### Marble Pattern Colors (Out of Stock Production Process 4-8 weeks)

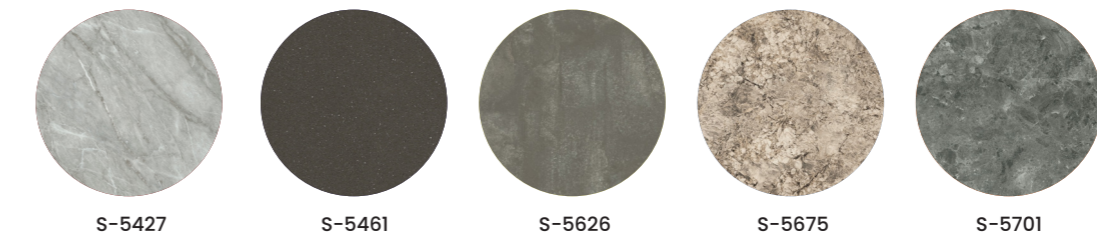



## Product Care

### Why is maintenance necessary?

It is critical to maintain stainless surfaces in order to maximize product life and corrosion resistance.

### What supplies are needed?

This is simply accomplished by dampening a clean cloth in warm water with a tiny bit of detergent or soap.

### How to care?

To begin, use a wet cloth to remove coarse grit and grime from the product to be cared for.

Next, thoroughly rinse your cloth. Wiping effectively requires gently rubbing the substance or ingredients.

### Attention!

Product maintenance should not be performed using carbon steel brushes or wool wire.



## Product Warranty

### Warranty

For two years, SANDER guarantees all of its products against corrosion and mechanical flaws.

(\*) Our organization accepts no liability in the following situations:

Failure to follow assembly instructions,

In the case of wear and tear caused by maintenance mistakes, in the case of loss or damage caused by user errors, in the case of incorrect disassembly, removal, or replacement, and in the transportations used to carry the product from one location to another.

### (\*\*) The right to change

SANDER retains the right to make modifications to standard product features and dimensions without previous notification in order to adhere to the idea of always enhancing service quality.



# SANDER

From Turkey to the World, with **environmental,**  
ecological, and national values...



# SANDER

Adding values to your living spaces



Contact Us

**0850 255 39 55**



## SALES OFFICE

Regus Ofis Park  
Merkez Mah. Baęlar Cad. No:14  
C2 Blok Zemin Kat, 34406  
**Kaęthane İstanbul, Türkiye**

✉ [teklif@sander.com.tr](mailto:teklif@sander.com.tr)

🌐 [www.sanderkabin.com.tr](http://www.sanderkabin.com.tr)



## FACTORY

Mehmet Akif Mah.  
Petrol Yolu Cad. No:212 A  
**Sultanbeyli, İstanbul Türkiye**

✉ [info@sander.com.tr](mailto:info@sander.com.tr)

🌐 [www.sander.com.tr](http://www.sander.com.tr)